

# 2020

## TØRFODER - FODERAUTOMATER



**ACO**

**FUNKI**

Gældende fra 1. juni 2020









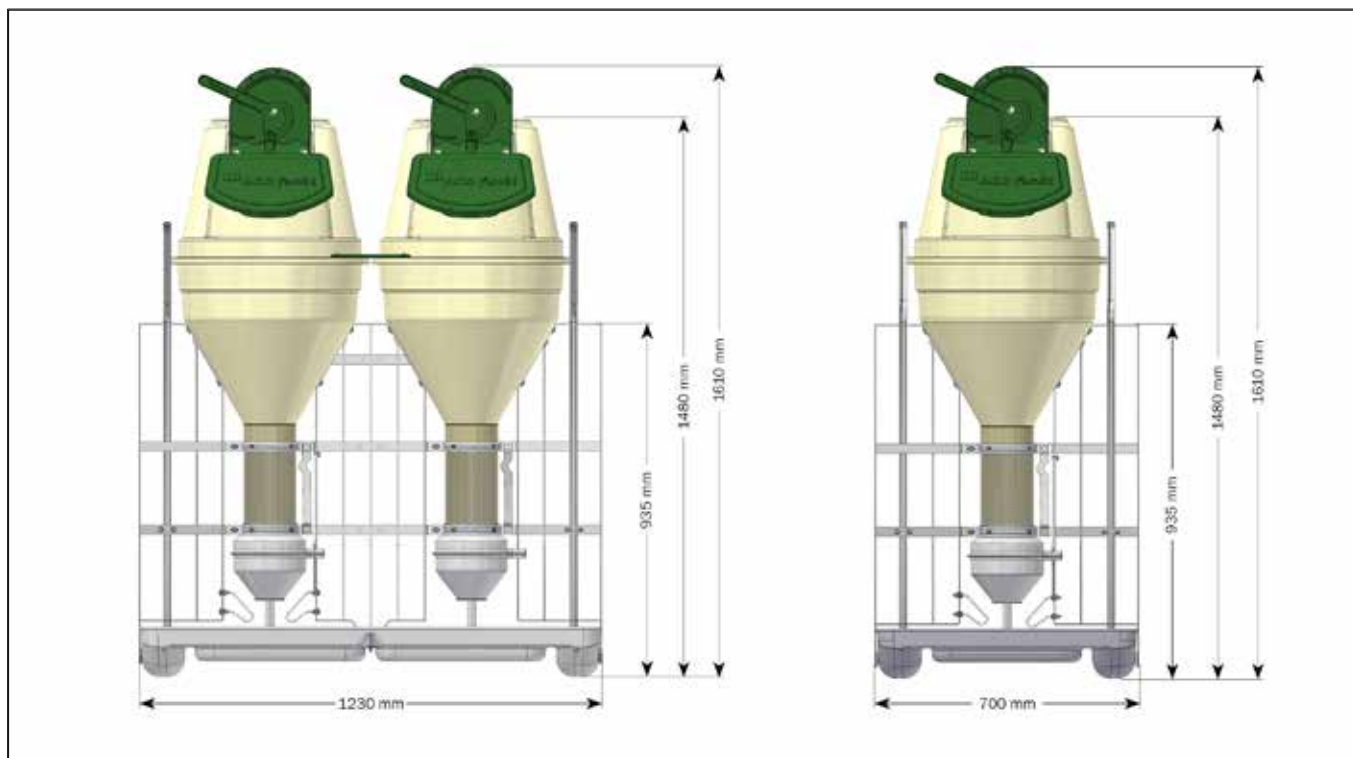



[www.acofunki.dk](http://www.acofunki.dk)



















## INDHOLDSFORTEGNELSE

FUNKIMAT .....	3
DOBBELT FUNKIMAT .....	4
FUNKIMAT TILBEHØR .....	4
COMBI FEEDER .....	5
BABY FEEDER .....	6
TUBE-O-MAT VI+ .....	7
TUBE-O-MAT CLASSIC .....	8
TUBE-O-MAT VI+ LTD .....	9
TUBE-O-MAT CLASSIC LTD .....	11
TUBE-O-MAT RØR .....	12
TUBE-O-MAT TILBEHØR .....	13
3IN1 NX .....	14
BOX FEEDER - SMÅGRISE .....	16
BOXFEEDER - SLAGTESVIN .....	18
CCM FEEDER .....	19
FODERNEDLØB T-STYKKE .....	20
FODERNEDLØB FAST STYKKE .....	21
FODERNEDLØB TILBEHØR .....	21
FODERNEDLØB FAST STYKKE - Ø75 MM UDLØB .....	21
VANDFORSYNING .....	22
8 MM AQUA SPEED .....	24
10 MM AQUA SPEED .....	24
15 MM AQUA SPEED .....	25
SALGS- OG LEVERINGSBETINGELSER .....	26



<p><b>Funkimat</b></p>	 <p><b>560560M</b> FUNKIMAT SMÅRISE MED POLYMER KRYBBE (FLAD-FLAD)</p>	 <p><b>560560U</b> FUNKIMAT SMÅRISE MED POLYMER KRYBBE (FLAD-FLAD)</p>	 <p><b>560561M</b> FUNKIMAT SLAGTESVIN MED POLYMER KRYBBE (FLAD-FLAD)</p>	 <p><b>560561U</b> FUNKIMAT SLAGTESVIN MED POLYMER KRYBBE (FLAD-FLAD)</p>
 <p><b>560710M</b> FUNKIMAT SMÅRISE MED RUSTFRI KRYBBE (FLAD-FLAD)</p>	 <p><b>560710U</b> FUNKIMAT SMÅRISE MED RUSTFRI KRYBBE (FLAD-FLAD)</p>	 <p><b>560711M</b> FUNKIMAT SLAGTESVIN MED RUSTFRI KRYBBE (FLAD-FLAD)</p>	 <p><b>560711U</b> FUNKIMAT SLAGTESVIN MED RUSTFRI KRYBBE (FLAD-FLAD)</p>	 <p><b>0227-088</b> DOSERINGSSKIVE VER. 3</p>
 <p><b>0227-309</b> DOSERINGSSKIVE VER. 4 LILLE</p>	 <p><b>0227-370</b> LÅSEFJEDER FOR DOSERINGS-HOVED, RUSTFRI FUNKIMAT, VER. 2</p>	 <p><b>38524</b> MONTAGE SÆT TIL U-STOLPE MOD FODERAUTOMATER</p>		

<p><b>Dobbelt Funkimat</b></p>	 <p><b>0227-670</b> DOBBELT FUNKIMAT (FLAD-FLAD) USAMLET</p>	 <p><b>0227-714</b> RF KRYBBE SMÅRISE FOR DOBBELT FUNKIMAT, KOMPLET</p>	 <p><b>0227-715</b> RF KRYBBE SLAGTESVIN FOR DOBBELT FUNKIMAT, KOMPLET</p>	 <p><b>0227-800</b> DOBBELT FUNKIMAT (FLAD-FLAD) SMÅGRIS - SAMLET</p>
 <p><b>0227-900</b> DOBBELT FUNKIMAT (FLAD-FLAD) SLAGTESVIN - SAMLET</p>	 <p><b>38524</b> MONTAGE SÆT TIL U-STOLPE MOD FODERAUTOMATER</p>			
<p><b>Funkimat Tilbehør</b></p>	 <p><b>0227-319</b> KRYDS FOR BRODANNELSE TIL FUNKIMAT OG 311 ROTO</p>	 <p><b>0227-558</b> LDPE PLADE TIL DOBBELT FUNKIMAT OG 3IN1 ROTO 10X1200X1200 MM</p>	 <p><b>0227-559</b> LDPE PLADE TIL ENKELT FUNKIMAT OG 311 ROTO 10X670X1200 MM</p>	 <p><b>0227-366</b> BEN FOR DOBBELT FUNKIMAT 948 MM</p>
 <p><b>0227-274</b> MASSIVT BEN F/FODERAUTOMAT 950 MM</p>	 <p><b>0227-150</b> RF KRYBBEFOD JUSTERBAR FOR FODERAUTOMAT</p>	 <p><b>12100107</b> DRIKKEVENTIL 1/2 RF TYPE 13</p>	 <p><b>0227-580</b> VANDTILSLUTNING TIL ENKELT AUTOMAT, 10 MM AQUASPEED MED 1/2' UDVENDIG GEVIND</p>	 <p><b>0227-587</b> BÆRING FOR FODERRØR</p>
 <p><b>0227-579</b> VANDTILSLUTNING TIL DOBBELT AUTOMAT 10 MM AQUASPEED MED 1/2' UDVENDIG GEVIND</p>	 <p><b>0227-597</b> BÆRING FOR FODERRØR, DOBBELT FODERAUTOMAT</p>			

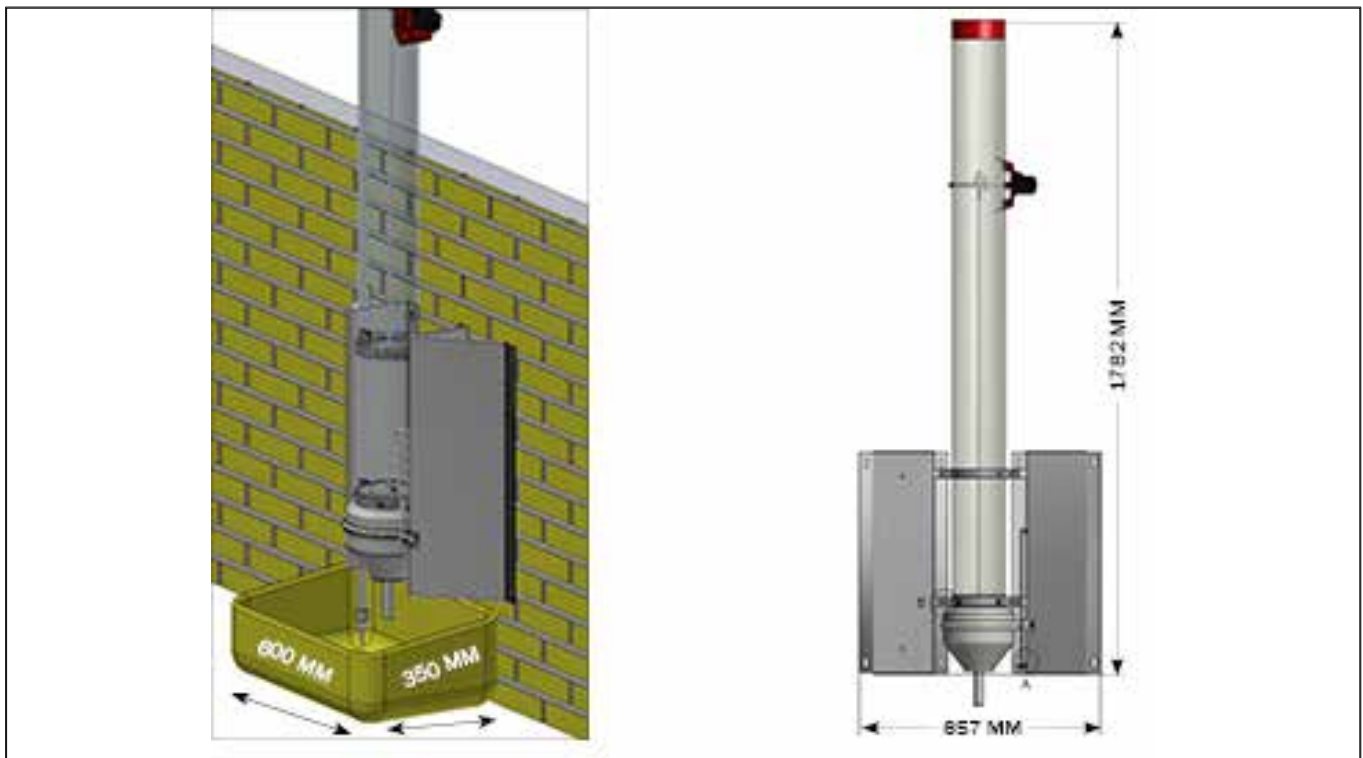

<b>Combi Feeder</b>	 <b>0227-495</b> COMBI FEEDER KOMPLET	 <b>0227-480</b> VANDRØR TIL COMBI FEEDER	 <b>09550</b> ENKELTTRUG T35-50, TIL NEDSTØBNING	 <b>09552</b> ENKELTTRUG T35-60, TIL NEDSTØBNING

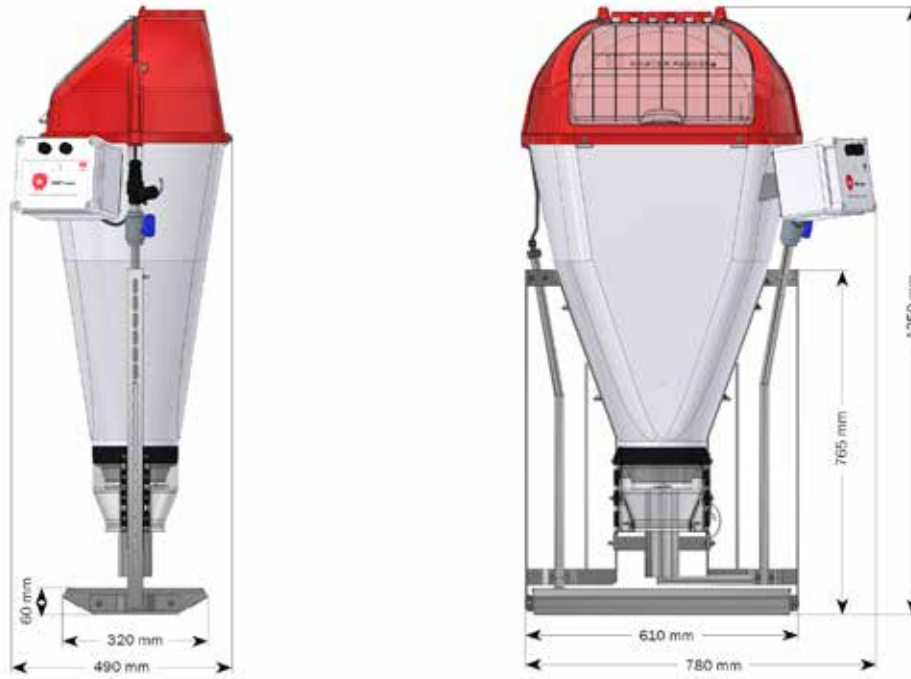

**0229-000**  
BABY FEEDER



**0229-001**  
PLADE OG TILBEHØR TIL FRIT-STÅENDE BABY FEEDER











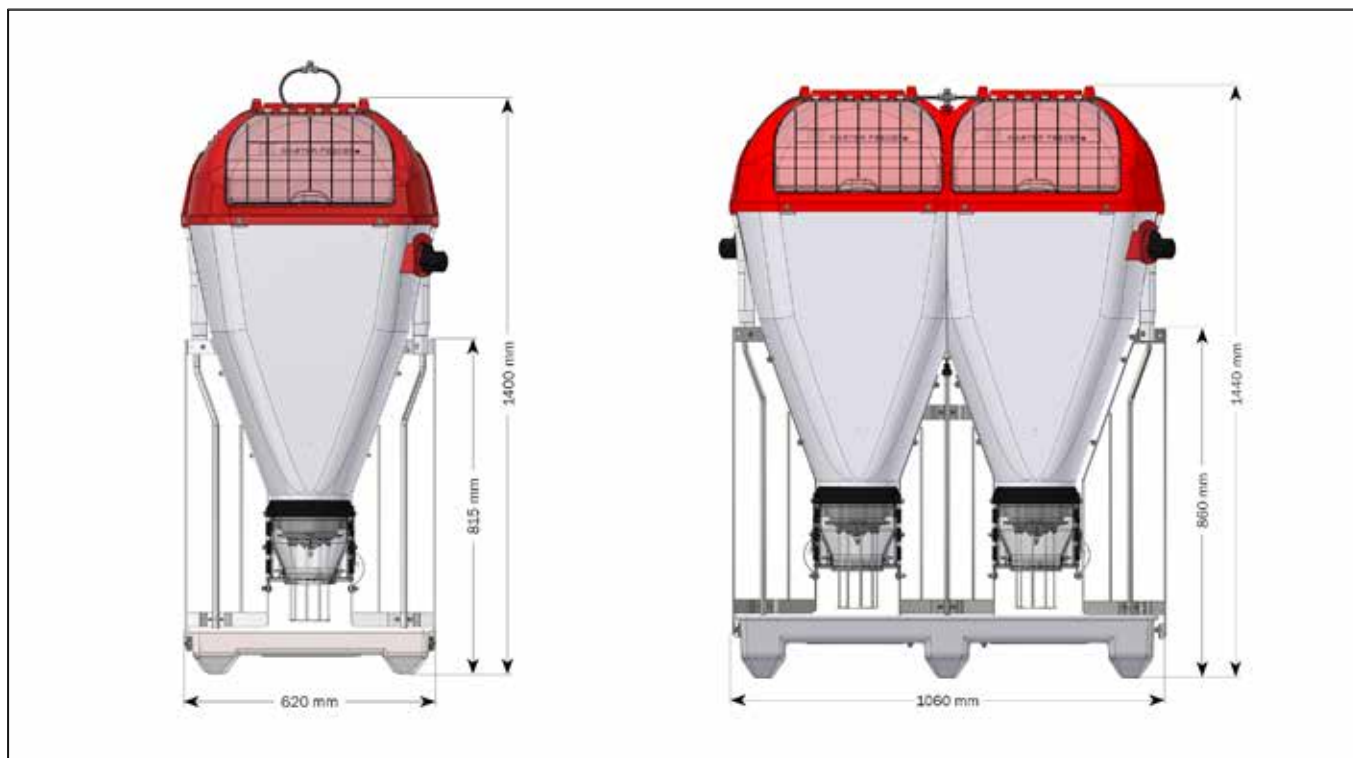



**0229-034**  
DOSERINGSSKIVE Ø129 LDPE











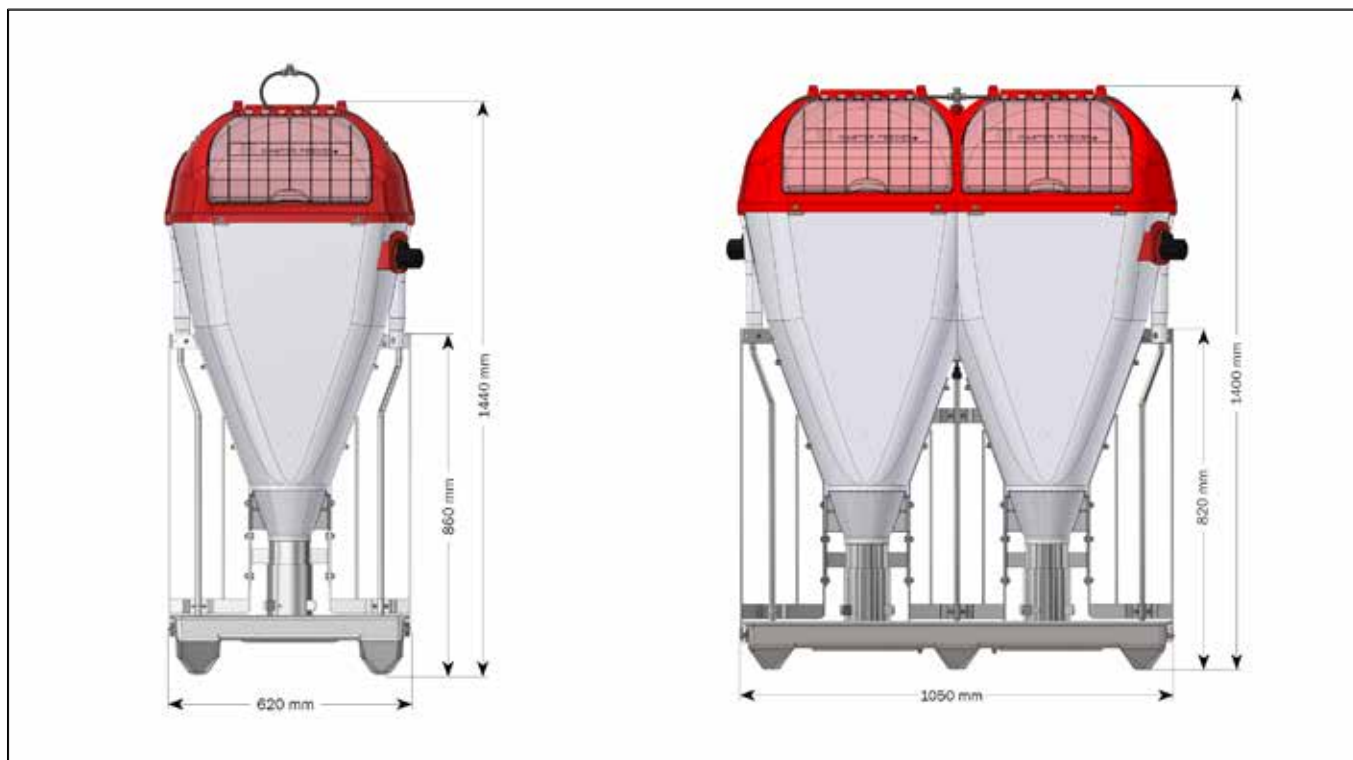



**0229-033**  
DOSERINGSSKIVE Ø125 LDPE

**Baby Feeder**











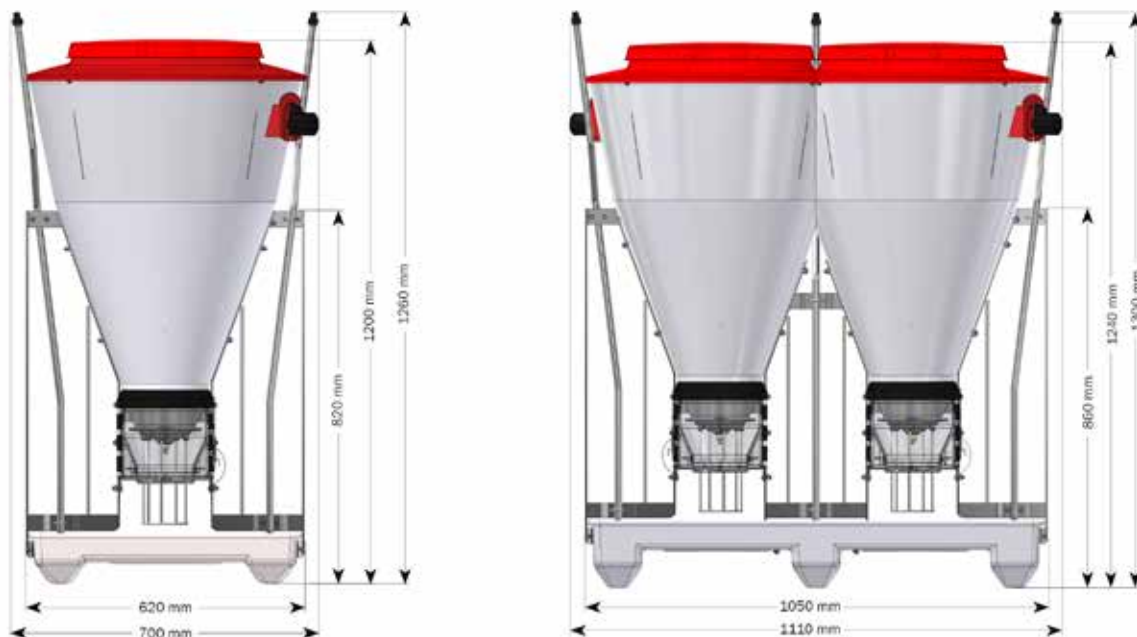





<b>TUBE-O-MAT® VI+</b>	 <b>89550M</b> TUBE-O-MAT® VI+ FRATS	 <b>89550U</b> TUBE-O-MAT® VI+ FRATS	 <b>89560M</b> TUBE-O-MAT® VI+ SLAGTESVIN	 <b>89560U</b> TUBE-O-MAT® VI+ SLAGTESVIN	
	 <b>89650M</b> TUBE-O-MAT® VI+ JUMBO FRATS	 <b>89650U</b> TUBE-O-MAT® VI+ JUMBO FRATS	 <b>89660M</b> TUBE-O-MAT® VI+ JUMBO SLAGTESVIN	 <b>89660U</b> TUBE-O-MAT® VI+ JUMBO SLAGTESVIN	 <b>38524</b> MONTAGE SÆT TIL U-STOLPE MOD FODERAUTOMATER
	 <b>76262</b> MONTAGESÆT UDFODRINGSDEL TIL TUBE-O-MAT OG LTD VI+	 <b>93245</b> VIPPEVENTIL TIL TUBE-O-MAT® 3/8' IND. GEVIND			



<b>TUBE-O-MAT® CLASSIC</b>	 <b>89585M</b> TUBE-O-MAT® CLASSIC FRATS	 <b>89585U</b> TUBE-O-MAT® CLASSIC FRATS	 <b>89587M</b> TUBE-O-MAT® CLASSIC SLAGTESVIN	 <b>89587U</b> TUBE-O-MAT® CLASSIC SLAGTESVIN	
	 <b>89685M</b> TUBE-O-MAT® CLASSIC JUMBO FRATS	 <b>89685U</b> TUBE-O-MAT® CLASSIC JUMBO FRATS	 <b>89687M</b> TUBE-O-MAT® CLASSIC JUMBO SLAGTESVIN	 <b>89687U</b> TUBE-O-MAT® CLASSIC JUMBO SLAGTESVIN	 <b>38524</b> MONTAGE SÆT TIL U-STOLPE MOD FODERAUTOMATER
	 <b>76275</b> MONTAGESÆT UDFODRINGS- DEL TIL TUBE-O-MAT OG LTD CLASSIC	 <b>93245</b> VIPPEVENTIL TIL TUBE-O- MAT® 3/8" IND. GEVIND			
	<b>563</b>				











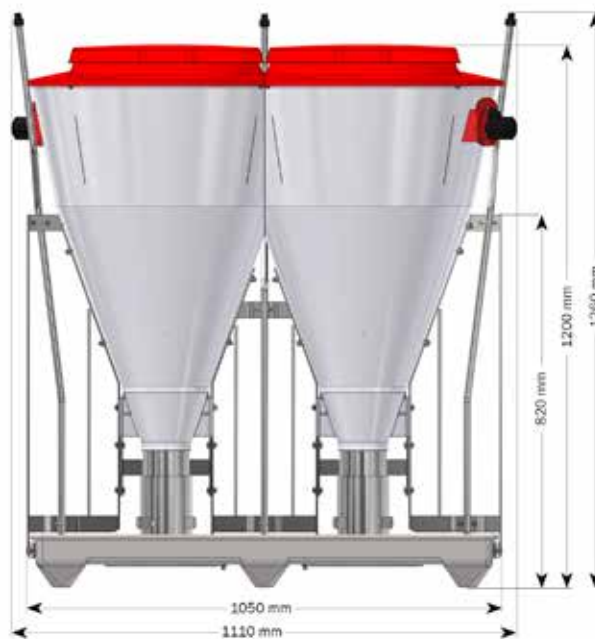







<b>TUBE-O-MAT® VI+ LTD.</b>	 <b>89551M</b> TUBE-O-MAT® VI+ LTD. FRATS	 <b>89551U</b> TUBE-O-MAT® VI+ LTD. FRATS	 <b>89561M</b> TUBE-O-MAT® VI+ LTD. SLAG- TESVIN	 <b>89561U</b> TUBE-O-MAT® VI+ LTD. SLAG- TESVIN	
	 <b>89651M</b> TUBE-O-MAT® VI+ LTD. JUMBO FRATS	 <b>89651U</b> TUBE-O-MAT® VI+ LTD. JUMBO FRATS	 <b>89661M</b> TUBE-O-MAT® VI+ LTD. JUMBO SLAGTESVIN	 <b>89661U</b> TUBE-O-MAT® VI+ LTD. JUMBO SLAGTESVIN	 <b>38524</b> MONTAGE SÆT TIL U-STOLPE MOD FODERAUTOMATER
	 <b>76262</b> MONTAGESÆT UDFODRINGS- DEL TIL TUBE-O-MAT OG LTD VI+	 <b>93245</b> VIPPEVENTIL TIL TUBE-O- MAT® 3/8" IND. GEVIND	 <b>70710</b> PLASTTRAGT TUBE-O- MAT®2001	 <b>70725</b> PLASTTRAGT TUBE-O-MAT® JUMBO RUND 2009	 <b>72395</b> SPIRAL LILLE TOP



**72391**  
SPIRAL STOR VI+





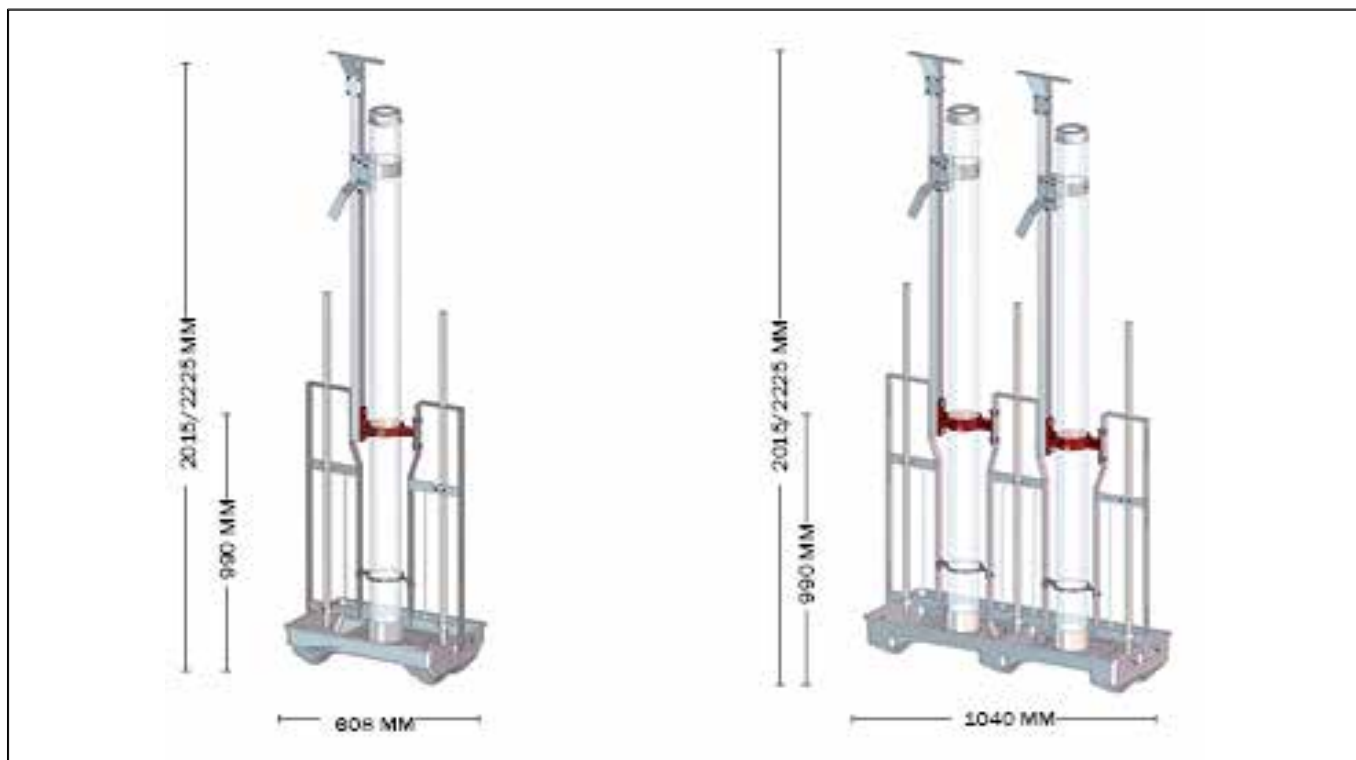



<b>TUBE-O-MAT® CLASSIC LTD.</b>	 <b>89590M</b> TUBE-O-MAT® CLASSIC LTD. FRATS	 <b>89590U</b> TUBE-O-MAT® CLASSIC LTD. FRATS	 <b>89595M</b> TUBE-O-MAT® CLASSIC LTD. SLAGTESVIN	 <b>89595U</b> TUBE-O-MAT® CLASSIC LTD. SLAGTESVIN	
	 <b>89690M</b> TUBE-O-MAT® CLASSIC LTD. JUMBO FRATS	 <b>89690U</b> TUBE-O-MAT® CLASSIC LTD. JUMBO FRATS	 <b>89695M</b> TUBE-O-MAT® CLASSIC LTD. JUMBO SLAGTESVIN	 <b>89695U</b> TUBE-O-MAT® CLASSIC LTD. JUMBO SLAGTESVIN	 <b>38524</b> MONTAGE SÆT TIL U-STOLPE MOD FODERAUTOMATER
	 <b>76275</b> MONTAGESÆT UDFODRINGS- DEL TIL TUBE-O-MAT OG LTD CLASSIC	 <b>93245</b> VIPPEVENTIL TIL TUBE-O- MAT® 3/8" IND. GEVIND	 <b>70710</b> PLASTTRAGT TUBE-O- MAT®2001	 <b>70725</b> PLASTTRAGT TUBE-O-MAT® JUMBO RUND 2009	

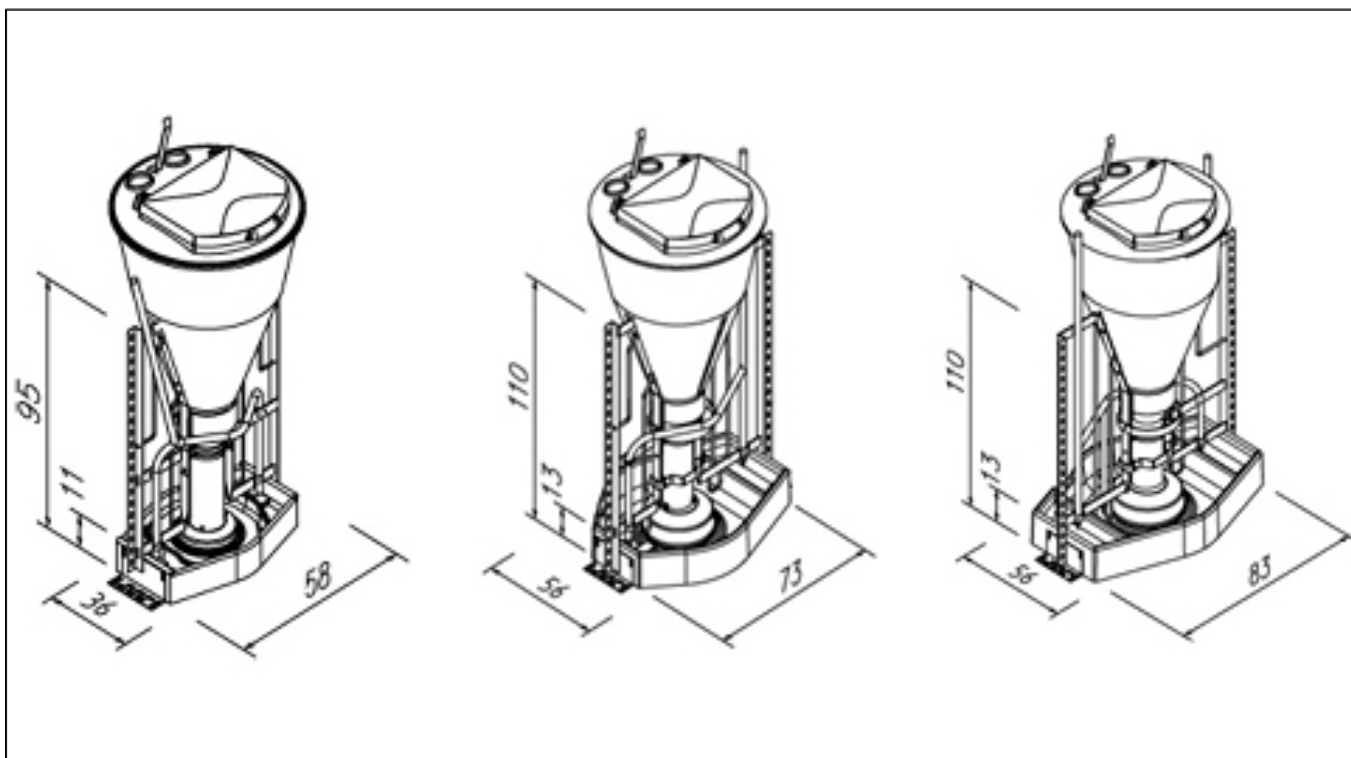

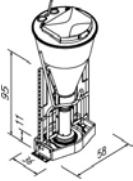
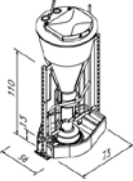
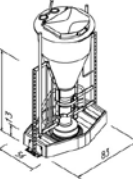





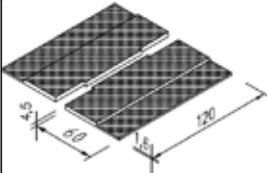
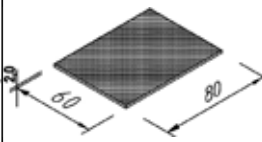

<p><b>TUBE-O-MAT® RØR</b></p>	 <p><b>89504M</b> TUBE-O-MAT® RØR SLAGTE-SVIN</p>	 <p><b>89504U</b> TUBE-O-MAT® RØR SLAGTE-SVIN</p>	 <p><b>89684M</b> TUBE-O-MAT® RØR JUMBO SLAGTESVIN</p>	 <p><b>89684U</b> TUBE-O-MAT® RØR JUMBO SLAGTESVIN</p>
-----------------------------------	---	---	--	--

<p><b>TUBE-O-MAT</b> Tilbehør</p>	 <p><b>71008</b> TRUG VI+ FRATS, 11 X 40 X 60 CM</p>	 <p><b>71009</b> TRUG VI+ OG RØR SLAGTESVIN, 15 X 40 X 60 CM</p>	 <p><b>71029</b> TRUG CLASSIC FRATS, 11 X 40 X 60 CM</p>	 <p><b>71069</b> TRUG CLASSIC FRATS JUMBO, 11 X 40 X 103,5 CM</p>
 <p><b>71030</b> TRUG CLASSIC SLAGTESVIN, 15 X 40 X 60 CM</p>	 <p><b>71070</b> TRUG CLASSIC SLAGTESVIN JUMBO, 15 X 40 X 103,5 CM</p>	 <p><b>0170-201</b> ENKELT TRUG TOM V+ OG CLASSIC WTF 11X40X60 CM</p>	 <p><b>0170-202</b> DOBBELT TRUG TOM V+ OG CLASSIC 11X40X103 CM</p>	 <p><b>74501</b> FODBESLAG 16 CM HØJ, 18 CM BRED - SLAGTESVIN TUBE-O-MAT®</p>
 <p><b>74502</b> FODBESLAG 12 CM HØJ, 18 CM BRED - FRATS TUBE-O-MAT®</p>	 <p><b>74503</b> FODBESLAG 16 CM HØJ, 25 CM BRED - SLAGTESVIN TUBE-O-MAT®</p>	 <p><b>74504</b> FODBESLAG 12 CM HØJ, 25 CM BRED - FRATS</p>	 <p><b>89014</b> PLADEGULV TIL ENKELT TUBE-O-MAT 10X608X1200 MM</p>	 <p><b>89016</b> PLADEGULV TIL DOBBELT TUBE-O-MAT 10X1040X1200 MM</p>

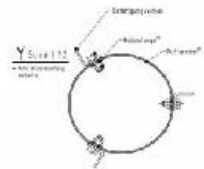

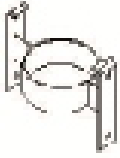

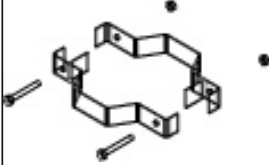





<p><b>3IN1 NX</b></p>	 <p><b>18099</b> 3IN1 NX MINI 60W, 120 L VINKELRAMME, 30-40 DYR/ AUTOMAT - USAMLET</p>	 <p><b>18858</b> 3IN1 NX MINI 60W, 120 L MED VINKELRAMME, 30-40 DYR/ AUTOMAT</p>	 <p><b>18100</b> 3IN1 NX MAXI 70W, 120 L VINKELRAMME, 50-60 DYR/ AUTOMAT - USAMLET</p>	 <p><b>18860</b> 3IN1 NX MAXI 70W, 120 L MED VINKEL RAMME, 50-60 DYR/AUTOMAT</p>
 <p><b>18202</b> 3IN1 NX MAXI 80W, 120 L MED VINKELRAMME, 60-75 DYR/AUTOMAT - USAMLET</p>	 <p><b>18862</b> 3IN1 NX MAXI 80W, 120 L MED VINKELRAMME, 60-75 DYR/AUTOMAT</p>	 <p><b>281490</b> TRYKVENTIL 3IN1 RF 1/2' UDV.</p>	 <p><b>281496</b> VIPPEVENTIL TIL TOM RØR 1/2' UDVENDIG GEVIND RF</p>	 <p><b>550580</b> PLASTTRAGT TIL 3IN1 NX 120 L</p>
 <p><b>550588</b> PLASTLÅG TIL 3IN1 - STOR DEL HVID</p>	 <p><b>550589</b> PLASTLÅG TIL 3IN1 NX - LILLE DEL HVID</p>	 <p><b>550598</b> TILBEHØRSKASSE, 3IN1 NX</p>	 <p><b>281518</b> GLIDEELEMENT TIL 3I1 NX</p>	 <p><b>72395</b> SPIRAL LILLE TOP</p>

















 <p><b>18846</b> RECEPTION RING FOR HOPPER 311</p>	 <p><b>550599</b> BUND TRAGT FOR 3IN1 FODERAUTOMAT</p>	 <p><b>281523</b> FODERRØR 311 NX MED PLASTKRAVE</p>	 <p><b>554168</b> FLISEMAT 120X60 CM TIL 3in1 AUTOMAT 2 STK. PR. AUTOMAT</p>	 <p><b>554167</b> FLISEMAT 80X60 CM</p>
<p><b>Sjældne reservedele</b></p>	 <p><b>281479</b> TILBEHØRSPOSE 311 FRATS 80</p>	 <p><b>18132</b> STOP VENTIL FOR 311 MAXI 80 HUSK PAKNING</p>	 <p><b>18615</b> RØREVÆRK, 311</p>	 <p><b>550583</b> ADAPTER KIT TIL 3IN1 NX TRAGT</p>
	 <p><b>18848</b> STYRERING RF FOR 311 NX</p>	 <p><b>18723</b> 311 FODERRØR MED RUSTFRI KRAVE</p>	 <p><b>18614</b> BEGRÆNSERSÆT TIL 3in1 AUTOMAT INKL. FASTGØRELSESSKRUER</p>	

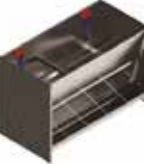
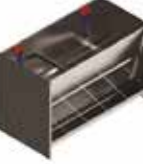
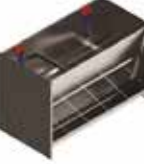
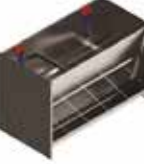
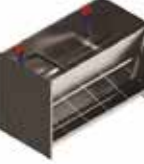
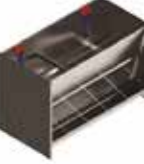



<b>Boxfeeder - Smågrise</b>	 <p><b>560042M</b> BOX FEEDERS SMÅGRISE 2X1 RF TRUG 41,5X74X31 CM SAMLET</p>	 <p><b>560042U</b> BOX FEEDERS SMÅGRISE 2X1 RF TRUG 41,5X74X31 CM USAMLET</p>	 <p><b>560043M</b> BOX FEEDERS SMÅGRISE 3X1 RF TRUG 61,5X74X31 CM SAMLET</p>	 <p><b>560043U</b> BOX FEEDERS SMÅGRISE 3X1 RF TRUG 61,5X74X31 CM USAMLET</p>	
	 <p><b>560044M</b> BOX FEEDERS SMÅGRISE 4X1 RF TRUG 81,5X74X31 CM SAMLET</p>	 <p><b>560044U</b> BOX FEEDERS SMÅGRISE 4X1 RF TRUG 81,5X74X31 CM USAMLET</p>	 <p><b>560045M</b> BOX FEEDERS SMÅGRISE 5X1 RF TRUG 101,5X74X31 CM SAMLET</p>	 <p><b>560045U</b> BOX FEEDERS SMÅGRISE 5X1 RF TRUG 101,5X74X31 CM USAMLET</p>	 <p><b>560046M</b> BOX FEEDERS SMÅGRISE 6X1 RF TRUG 121,5X74X31 CM SAMLET</p>
	 <p><b>560046U</b> BOX FEEDERS SMÅGRISE 6X1 RF TRUG 121,5X74X31 CM USAMLET</p>	 <p><b>560052M</b> BOX FEEDERS SMÅGRISE 2X2 RF TRUG 41,5X74X62 CM SAMLET</p>	 <p><b>560052U</b> BOX FEEDERS SMÅGRISE 2X2 RF TRUG 41,5X74X62 CM USAMLET</p>	 <p><b>560053M</b> BOX FEEDERS SMÅGRISE 3X2 RF TRUG 61,5X74X62 CM SAMLET</p>	 <p><b>560053U</b> BOX FEEDERS SMÅGRISE 3X2 RF TRUG 61,5X74X62 CM USAMLET</p>























 <p><b>560054M</b> BOX FEEDERS SMÅGRISE 4X2 RF TRUG 81,5X74X62 CM SAMLET</p>	 <p><b>560054U</b> BOX FEEDERS SMÅGRISE 4X2 RF TRUG 81,5X74X62 CM USAMLET</p>	 <p><b>560055M</b> BOX FEEDERS SMÅGRISE 5X2 RF TRUG 101,5X74X62 CM SAMLET</p>	 <p><b>560055U</b> BOX FEEDERS SMÅGRISE 5X2 RF TRUG 101,5X74X62 CM USAMLET</p>	 <p><b>560056M</b> BOX FEEDERS SMÅGRISE 6X2 RF TRUG 121,5X74X62 CM SAMLET</p>
 <p><b>560056U</b> BOX FEEDERS SMÅGRISE 6X2 RF TRUG 121,5X74X62 CM USAMLET</p>	 <p><b>560080M</b> BOX FEEDERS SMÅGRISE 5X2 RF MED VAND 92X44X62,5 CM SAMLET</p>	 <p><b>560080U</b> BOX FEEDERS SMÅGRISE 5X2 RF MED VAND 92X44X62,5 CM USAMLET</p>		

<p><b>Boxfeeder - Slagtesvin</b></p>	 <p><b>560062M</b> BOX FEEDERS SLAGTESVIN 2X1 RF TRUG 61,5X99X39 CM SAMLET</p>	 <p><b>560062U</b> BOX FEEDERS SLAGTESVIN 2X1 RF TRUG 61,5X99X39 CM USAMLET</p>	 <p><b>560063M</b> BOX FEEDERS SLAGTESVIN 3X1 RF TRUG 91,5X99X39 CM SAMLET</p>	 <p><b>560063U</b> BOX FEEDERS SLAGTESVIN 3X1 RF TRUG 91,5X99X39 CM USAMLET</p>
 <p><b>560064M</b> BOX FEEDERS SLAGTESVIN 4X1 RF TRUG 120,5X99X39 CM SAMLET</p>	 <p><b>560064U</b> BOX FEEDERS SLAGTESVIN 4X1 RF TRUG 120,5X99X39 CM USAMLET</p>	 <p><b>560065M</b> BOX FEEDERS SLAGTESVIN 5X1 RF TRUG 151,5X99X39 CM SAMLET</p>	 <p><b>560065U</b> BOX FEEDERS SLAGTESVIN 5X1 RF TRUG 151,5X99X39 CM USAMLET</p>	 <p><b>560072M</b> BOX FEEDERS SLAGTESVIN 2X2 RF TRUG 61,5X99X80 CM SAMLET</p>
 <p><b>560072U</b> BOX FEEDERS SLAGTESVIN 2X2 RF TRUG 61,5X99X80 CM USAMLET</p>	 <p><b>560073M</b> BOX FEEDERS SLAGTESVIN 3X2 RF TRUG 91,5X99X80 CM SAMLET</p>	 <p><b>560073U</b> BOX FEEDERS SLAGTESVIN 3X2 RF TRUG 91,5X99X80 CM USAMLET</p>	 <p><b>560074M</b> BOX FEEDERS SLAGTESVIN 4X2 RF TRUG 120,5X99X80 CM SAMLET</p>	 <p><b>560074U</b> BOX FEEDERS SLAGTESVIN 4X2 RF TRUG 120,5X99X80 CM USAMLET</p>
 <p><b>560075M</b> BOX FEEDERS SLAGTESVIN 5X2 RF TRUG 151,5X99X80 CM SAMLET</p>	 <p><b>560075U</b> BOX FEEDERS SLAGTESVIN 5X2 RF TRUG 151,5X99X80 CM USAMLET</p>	 <p><b>560090M</b> BOX FEEDERS SLAGTE- SVIN 3X2 RF MED VAND 118,7X54,5X78,5 CM SAMLET</p>	 <p><b>560090U</b> BOX FEEDERS SLAGTE- SVIN 3X2 RF MED VAND 118,7X54,5X78,5 CM USAMLET</p>	 <p><b>560091M</b> BOX FEEDERS SLAGTE- SVIN 4X2 RF MED VAND 158X54,5X78,5 CM SAMLET</p>
 <p><b>560091U</b> BOX FEEDERS SLAGTE- SVIN 4X2 RFMED VAND 158X54,5X78,5 CM USAMLET</p>	 <p><b>560092M</b> BOX FEEDERS SLAGTE- SVIN 5X2 RFMED VAND 198X54,5X78,5 CM SAMLET</p>	 <p><b>560092U</b> BOX FEEDERS SLAGTE- SVIN 5X2 RF MED VAND 198X54,5X78,5 CM USAMLET</p>		









<p><b>CCM Feeder</b></p>	 <p><b>18746</b> CCM MAXI TYP II (71 L) TRUG M/DOME, SLSVIN 25-115 KG, 30-40 DYR/AUTOMAT</p>	 <p><b>18090</b> CCM-FEEDER MINI 40L SMÅGRIS 5-35 KG, 30-40 PR. AUTOMAT, TRUG Ø50/10 CM HØJ</p>	



<p><b>Fodernedløb T-stykke</b></p>	 <p><b>0227-591</b> FODERNEDLØB Ø63X1000 INKLUSIV Ø38 T-STYKKE</p>	 <p><b>0227-592</b> FODERNEDLØB Ø63X1000 INKLUSIV Ø60 T-STYKKE</p>	 <p><b>0227-593</b> FODERNEDLØB Ø63X3000 INKLUSIV Ø38 T-STYKKE</p>	 <p><b>0227-594</b> FODERNEDLØB Ø63X3000 INKLUSIV Ø60 T-STYKKE</p>
 <p><b>0142-015</b> T-STYKKE MED SKOD, Ø38</p>	 <p><b>0232-010</b> T-STYKKE MED SKOD Ø60</p>	 <p><b>0232-009</b> SKOD (SORT)</p>	 <p><b>0232-007</b> SKOD FOR T-STYKKE -FLAD MODEL</p>	

<p><b>Fodernedløb Fast stykke</b></p>	 <p><b>90550</b> FODERNEDLØB 38 MM MED FAST T-STYKKE</p>	 <p><b>90552</b> FODERNEDLØB 50 MM MED FAST T-STYKKE</p>	 <p><b>90554</b> FODERNEDLØB 60 MM MED FAST T-STYKKE</p>	 <p><b>90571</b> FODERNEDLØB 38 MM Y- MODEL MED FAST T-STYKKE</p>
 <p><b>90573</b> FODERNEDLØB 50 MM Y- MODEL MED FAST T-STYKKE</p>	 <p><b>90574</b> FODERNEDLØB 60 MM Y- MODEL MED FAST T-STYKKE</p>	 <p><b>90560</b> FODERNEDLØB 38 MM MED FAST T-STYKKE FOR RØRAUTO- MAT</p>	 <p><b>90562</b> FODERNEDLØB 50 MM MED FAST T-STYKKE FOR RØR- AUTOMAT</p>	 <p><b>90564</b> FODERNEDLØB 60 MM MED FAST T-STYKKE FOR RØR- AUTOMAT</p>
 <p><b>90482</b> FAST T-STYKKE TIL 38 MM</p>	 <p><b>90484</b> FAST T-STYKKE TIL 50 MM</p>	 <p><b>90486</b> FAST T-STYKKE TIL 60 MM</p>		
<p><b>Fodernedløb Tilbehør</b></p>	 <p><b>0228-595</b> TELESKOP MED NEDLØB</p>	 <p><b>0228-588</b> NEDLØB Ø63X2 1000 MM MED HUL</p>	 <p><b>90268</b> MASTER COLLAR PLASTKRA- VE, NEDLØB</p>	 <p><b>90212</b> Y-FORGRENING ABS 63 MM 30 GR.</p>
<p><b>Fodernedløb Fast stykke - Ø75 MM Udløb</b></p>	 <p><b>0228-488</b> FAST T-STYKKE TIL 76 MM</p>	 <p><b>90249</b> FODERNEDLØB PLAST 75 SPEC. LÆNGDE</p>	 <p><b>0228-480</b> TELESKOPRØR Ø80</p>	 <p><b>0228-510</b> Y-STYKKE 75 MM 60°</p>

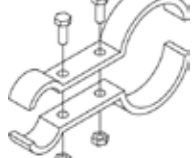

<p><b>Vandforsyning</b></p>	 <p><b>20000055</b> PVC RØR M/ KLÆBEMUFFE 32 MM TN1 PRIS PR. METER, LÆNGDE 5 METER</p>	 <p><b>23900341</b> MUFFE PVC 32MM TN16</p>	 <p><b>23900344</b> SLUTMUFFE PVC 32MM</p>	 <p><b>23900351</b> GEVINDMUFFE PVC 1/2" 32MM IN</p>
 <p><b>60176</b> 32 MM - 3/4 OVERGANG MUFFE/INDVENDING GEVIND</p>	 <p><b>23900343</b> GEVINDMUFFE PVC 1" 32MM INDV</p>	 <p><b>60188</b> 32 MM - 3/4 MUFFE/UDVEN- DIGT GEVIND</p>	 <p><b>60190</b> 32 MM - 1 OVERGANG UDVEN- DIGT GEVIND/MUFFE</p>	 <p><b>23900345</b> UNION PVC 32MM</p>
 <p><b>23900338</b> VINKEL PVC 90 GR. 32MM TN16</p>	 <p><b>23900340</b> TEE PVC 90 GR. 32MM TN16</p>	 <p><b>23900347</b> TEE PVC 32MMX1/2"X32MM</p>	 <p><b>23900363</b> KRYDS PVC 32MM</p>	 <p><b>23900358</b> KUGLEHANE PVC Ø32MM, 1 X UNION</p>

 <p><b>60200</b> 1/2 - 1/2" UDVENDIGT GE- VIND/UDVENDIGT GEVIND PVC</p>	 <p><b>23900299</b> BRYSTNIPPEL PVC NIF 1"</p>	 <p><b>8500532</b> VANDRØRS HOLDER TIL 32 MM PVC RØR</p>	 <p><b>3900265</b> Ø32 VANDRØR HOLDER PÅ TOPPEN AF FIBER PLADE</p>	 <p><b>23900386</b> MELLEMLÆG FOR 32 MM PVC RØRBÆRER</p>
 <p><b>3900084</b> RØRBESLAGSÆT FOR Ø32MM PVC-RØR MOD MUR</p>	 <p><b>3900095</b> RØRBESLAGSÆT FOR Ø32MM PVC-RØR MOD PLANKE</p>	 <p><b>3900086</b> RØRBÆRING 5 X 10 CM, KOMPLET</p>	 <p><b>3900091</b> RØRBESLAG Ø38-Ø32, KOMPLET</p>	 <p><b>3900092</b> RØRBESLAG Ø60-Ø32, KOMPLET</p>
 <p><b>4900945</b> VANDFILTER SÆT</p>	 <p><b>560573</b> FILTER TIL 93775 150 MY</p>	 <p><b>4900946</b> VANDMÅLER SÆT</p>	 <p><b>4900950</b> MEDICINBLANDER SÆT</p>	 <p><b>60450</b> OPHÆNGSSÆT TIL WIRE/ PIANOTRÅD</p>
 <p><b>02900021</b> PIANOTRÅD RF 2,0 MM</p>	 <p><b>02900000</b> FJEDERTRÅD GALV. Ø3,0 MM</p>	 <p><b>29100001</b> GEVINDTAPE, RULLE Å 10M</p>	 <p><b>18984</b> FLYDENDE PAKNING 100 ML TUBE</p>	 <p><b>23900112</b> LIM PEVICOL 0,5KG</p>
 <p><b>3900085</b> LIM PVC 150G TUBE + REN- SEVÆSKE</p>	 <p><b>76200023</b> KABELBINDER 290X4,5 SORT</p>			

<p><b>8 MM Aqua speed</b></p>	 <p><b>61012</b> SLANGE 8 MM PE</p>	 <p><b>61122</b> 8 MM - 1/4" LYNOVERG. MUFFE/UDVENDIGT GEVIND</p>	 <p><b>61124</b> 8 MM - 1/2" LYNOVERG. MUFFE/ UDVENDIGT GEVIND</p>	 <p><b>61140</b> OVERGANG 3/8 INDVENDIGT GEVIND X 8 MM MUFFE</p>
 <p><b>61148</b> 8 MM - 1/2 LYNOVERG. MUFFE/ INDVENDIGT GEVIND</p>	 <p><b>61226</b> 8 - 8 - 8 MM LYN T-STYKKE</p>	 <p><b>61171</b> 8 MM LYN VINKEL MUFFE/ MUFFE AQUASPEED</p>	 <p><b>61050</b> 8 MM LYN SAMLEMUFFE</p>	 <p><b>61310</b> 8 MM LYN KRYDS</p>
 <p><b>61230</b> 8 - 8 - 8 MM LYN Y-STYKKE</p>	 <p><b>61195</b> ANBORINGSBØJLE PLAST 8MM-32/33,7MM</p>	 <p><b>61286</b> NØD-STOPHANE TIL 8 MM SLANGER NY</p>	<p><b>10 MM Aqua speed</b></p>	
 <p><b>23900523</b> AQUASPEED OVERGANG MED UDVENDIGT GEVIND 10MMX1/2"</p>	 <p><b>23900524</b> AQUASPEED OVERGANG MED INDVENDIGT GEVIND 10MMX1/4"</p>	 <p><b>23900525</b> AQUASPEED OVERGANG MED INDVENDIGT GEVIND 10MMX1/2"</p>	 <p><b>23900528</b> AQUASPEED SAMLEMUFFE 10 MM</p>	 <p><b>23900533</b> AQUASPEED Y-STYKKE 10 MM</p>
 <p><b>23900526</b> AQUASPEED T-STYKKE 10 MM</p>	 <p><b>23900538</b> AQUASPEED REDUKTION MUFFE 10/8 MM</p>	 <p><b>23900534</b> AQUASPEED OVERGANG 10/15MM</p>	 <p><b>23961195</b> ANBORINGSBØJLE PLAST 10 MM-32/33,7 MM</p>	 <p><b>23900537</b> STOPHANE TIL 10 MM SLAN- GER</p>



<p><b>15 MM Aqua speed</b></p>	 <p><b>23900500</b> PE-SLANGE 15X1,5 MM - LBM</p>	 <p><b>23900502</b> AQUASPEED BØJNING 90° 15 MM</p>	 <p><b>23900503</b> AQUASPEED OVG 15MMX1/2" UDVENDIGT GEVIND</p>	 <p><b>23900504</b> AQUASPEED OVG 15MMX1/2" INDVENDIGT GEVIND</p>
 <p><b>23900505</b> AQUASPEED SLUTMUFFE 15 MM</p>	 <p><b>23900506</b> AQUASPEED INDSTIKSV. 90° 15 MM</p>	 <p><b>23900507</b> AQUASPEED SAMLEMUFFE 15 MM</p>	 <p><b>23900508</b> AQUASPEED T-STYKKE 15 MM</p>	 <p><b>23900527</b> AQUASPEED T-STYKKE 15/10/15 MM</p>
 <p><b>23900509</b> AQUASPEED HANE 15 MM</p>	 <p><b>23900510</b> RØRSAKS TIL PVC RØR</p>	 <p><b>2900460</b> RØRBÆRER MED SKRUE + DYBEL</p>		

## ACO FUNKI A/S salgs- og leveringsbetingelser

Denne prislister er gældende pr. 1.6.2020 og erstatter alle tidligere udsendte prislister. Alle priser er bruttopriser eksklusiv moms og i øvrigt iht. følgende generelle salgs- og leveringsbetingelser.

ACO FUNKI A/S tager forbehold for trykfejl samt produkt- og prisændringer.

Nedenstående salgs- og leveringsbetingelser finder anvendelse såfremt der ikke foreligger skriftlig aftale mellem ACO FUNKI A/S og køber om fravigelser.

### Tegninger og produktinformationer

Tegninger, tilbudstekst, illustrationer samt tekniske specifikationer og andre produkt informationer mv. er vejledende og uden forbindende og ACO FUNKI A/S kan ikke drages til ansvar for eventuelle fejl eller fejlfortolkninger, ej heller af bekendtgørelser, love m.m.

Projektmateriale (tegninger, illustrationer, tilbud m.m.) er ACO FUNKI A/S's ejendom, og må ikke overdrages til andre uden skriftligt tilsagn. ACO FUNKI A/S forbeholder sig ret til, hvis dette ikke overholdes, at fremsende faktura for interne omkostninger.

### Tilbud

Tilbuddet er afgivet med forbehold for mellemsalg og gyldighed begrænset til det i tilbuddet anførte. ACO FUNKI A/S forbeholder sig ret til at tilbagekalde et tilbud uden varsel.

### Priser

Alle priser er eksklusiv moms og baseret på de på tidspunktet for tilbuddet kendte afgifter og materiale priser. Der tages forbehold for evt. regulering af disse.

### Betalingsbetingelser

8 dage netto. Køber er ikke berettiget til at modregne med eventuelle modkrav, der ikke er skriftligt anerkendt af ACO FUNKI A/S. Ved betaling efter forfald påregnes rente på 1,5% pr. påbegyndt måned. ACO FUNKI A/S forbeholder sig ret til, på et hvert tidspunkt, at kræve garantistillelse for betaling.

### Ekspeditionsgebyr

Ordrer modtaget under DKK 4.000 netto pålægges et ekspeditionsgebyr på DKK 150.

### Leveringsbetingelser

Ab fabrik Herning iht. Incoterms 2010. (ACO FUNKI A/S har tegnet transport forsikring for alle leverancer uagtet leveringsklausul).

### Leveringstid

Iht. aftale mellem køber og ACO FUNKI A/S.

### Emballage

Paller og rammer faktureres til DKK 80 pr. stk. (Returnering er ikke mulig på grund af smitterisiko).

### Returnering af varer

Modtages kun såfremt dette udtrykkeligt er aftalt og i så fald kun for varer ACO FUNKI A/S fremstiller som standard varer der er returneret i original emballage og ikke har været monteret eller er blevet beskadiget på nogen måde. Kreditning vil ske til 80% af varens netto pris.

Såfremt ACO FUNKI A/S har projektansvar er overskydende varer ACO FUNKI A/S ejendom.

## Øvrige betingelser

### Montage

Montage er ikke inkluderet i ACO FUNKI A/S's tilbud, med mindre dette udtrykkeligt er anført i ordrebekræftelsen. Det samme gælder alt el/bygningsarbejde og fundering.

Montage udføres kun efter fast pris, såfremt montagestedet er tomt, ryddet op og i klargjort stand. Det er købers ansvar at materialerne er placeret tættest muligt på montagestedet, og adgangsforholdene er acceptable efter montageafdelingens vurdering.

Ved sammenfaldende arbejde, som udføres af andre faggrupper, udføres montage efter timeløn.

ACO FUNKI A/S forbeholder sig ret til at ændre den aftalte pris for projekter med fast montagepris, såfremt montageafdelingen ikke finder montagestedet klargjort – herunder fakturering af forbrugt tid på forgæves kørsel, timeløn, oprydning, flytning af varer o.a.

Selvbærende støbejern, betonspalter, polymer krybber er aldrig inkluderet i montagepriser, undtaget hvis det fremgår specifikt af ordrebekræftelsen.

Alle vandinstallationer slutter enten ved enden af rækken eller på indvendig side af sektionen, undtaget hvis det fremgår specifikt af ordrebekræftelsen.

Ved selvmontage er alt tilpasning af udstyr på eget ansvar (rør, planker m.m.) uanset tilkøb af supervision fra ACO FUNKI A/S

### Selvbærende støbejernsriste

Pga. produktionsmetoden kan der forekomme udsving i mål, og størrelse. Produktet kan derfor være uensartet.

Ingen af disse afvigelser har væsentlig betydning for produktets funktion. Støbejernsristene er kun beregnet til brug for grise og må ikke belastes på anden måde.

### Generelt

Der kan generelt fremkomme farveforskelle i produkterne, specielt i produkter fremstillet af div. PVC/plast/fiber materialer.

Alle typer vandventiler er designet til et arbejdstryk på 2,5-3,0 bar. Det er købers ansvar at måle og evt. regulere vandtrykket. ACO FUNKI A/S påtager sig ikke reklamationer på vandventiler anvendt ved et arbejdstryk over 3 bar.

Ved efterforsendelse af varer/ydelse grundet påståede mangler, forbeholder ACO FUNKI A/S sig ret til fakturering af varernes værdi samt øvrige omkostninger, såfremt der tidligere er sket levering, eller der ikke er grundlag for påberåbelse af mangler.

ACO FUNKI A/S fraskriver sig reklimationsansvar såfremt der tilsættes syre i vand/foder uden forudgående accept. Ligeledes i de tilfælde hvor indeklimaet ikke opfylder normerne for godt indeklima.

Varebeskrivelsen skal kun betragtes som vejledende og kan være behæftet med fejl. Derfor er det komponentstyklisten der er gældende for tilbuddet. Hvis denne ikke er vedlagt tilbuddet, påhviler det køber at rekvirere denne.

For leverancer eksklusiv montage gælder at alle øvrige forhold reguleres iht. NL92. Dog er det aftalt at punkt 11, sidste sætning samt punkt 13 og 14 ikke finder anvendelse.

For leverancer inklusiv montage gælder at alle øvrige forhold reguleres iht. NLM94. Dog er det aftalt at punkt 45, sidste sætning samt punkt 47 og 48 ikke finder anvendelse.



## STÆRKT BAGLAND

ACO FUNKI er en del af ACO Group, som er førende på markedet inden for dræningsteknologi. ACO står for professionel dræning, effektiv rengøring og en kontrolleret udledning eller genanvendelse af vand.

ACO Group bygger på omfattende research og udvikling, og teknisk ekspertise indenfor behandling af polymerbeton, plastik, støbejern, rustfrit stål, og forstærket beton.

ACO er tilstede i over 40 lande, med 30 produktionssteder fordelt på 4 kontinenter. Med 5.000 ansatte verden over, har ACO genereret salg for mere end 850 millioner Euro i 2018.

### DENMARK

Kirkevænget 5  
DK-7400 Herning  
T. +45 97119600  
F. +45 97119677  
[www.acofunki.dk](http://www.acofunki.dk)

### GERMANY

Vorwerksallee 14  
24782 Büdelsdorf  
T. +49 43316649711  
F. +49 43314378912  
[info@aco-funki.de](mailto:info@aco-funki.de)  
[www.aco-funki.de](http://www.aco-funki.de)

### FRANCE

Parc d'innovation de Mescoat  
29800 Landerneau  
T. +33 298 303685  
F. +33 298 215506  
[www.acofunki.fr](http://www.acofunki.fr)

### SPAIN

Cr. Major 52, 1r 1a  
08110 Montcada  
i Reixac (Barcelona)  
T. +34 935 650727  
F. +34 935 753678  
[www.acofunki.com](http://www.acofunki.com)

### RUSSIA

Kalinina str. 1  
396116 Verhnyaya Hava,  
Voronezh region  
T. +7 915 545 44 77  
[www.acofunki.ru](http://www.acofunki.ru)

### CHINA

山东省青岛市即墨区  
华山二路615号  
266200  
+86 0532 86657828  
[www.acofunki.com](http://www.acofunki.com)

### UKRAINE

Shevchenka str.73  
Kulykiv,  
80362 Zhovka  
Livi region  
[www.acofunki.com](http://www.acofunki.com)

### POLAND

Krzysztof Skwarek  
T. +48 256 83 15 98  
[Krzysztof.Skwarek@acofunki.com](mailto:Krzysztof.Skwarek@acofunki.com)  
[www.acofunki.com](http://www.acofunki.com)

